

INVACARE®

# Manual Wheelchair

Series



Yes, you can.®





For 30 years, Invacare has set the standard in manual wheelchairs. That tradition continues today as Invacare constantly works to improve designs while maintaining the important characteristics that providers and end-users have come to expect from Invacare® wheelchairs: durability, interchangeability, and value. This commitment to quality and to meeting the needs of providers and consumers is reflected in these features:

- Durable, low-maintenance designs that meet RESNA standards for manual wheelchair performance.
- A wide variety of ready-to-ship models in various configurations for quick delivery around the country.
- The ability to custom configure most of our wheelchairs to meet exact consumer needs.
- A full assortment of bariatric manual wheelchair solutions. In addition to our cornerstone products like the Tracer® IV and 9000 XDT wheelchairs, Invacare also introduced a bariatric transport chair and added a 1,000 lb. weight capacity option on the 9000 Topaz™ chair.

In all, Invacare continues to be committed to meeting both the needs of our customers and consumers worldwide with our standard wheelchair products.



**Bariatric/  
Heavy-Duty  
Designation**

Invacare products with the Bariatric/Heavy-Duty icon are designed for your bariatric patients whose height and weight require the use of a heavy-duty model. These products provide the same quality that all Invacare products possess. They also demonstrate our commitment to this product category.

## Table of Contents

Dimensions Chart	3
Transport Chair	4
Lightweight Aluminum Transport	5
Heavy-Duty Transport	6
Veranda™ Wheelchair	7
Tracer® EX2	8
Tracer® SX5	9
Tracer® SX5 Recliner	10
9000 SL	11
9000 XT	12
9000 XT Recliner	13
Tracer® IV	14
9000 XDT	15
9000 Topaz™	16
Invacare® 900 Series	17
Invacare® 900 Recliner	18
9000 Jymni™	19
9000 Jymni™ Recliner	20
Ramps and CLD	21
Accessories	22–23
Color Guide	24



# Invacare® Manual Wheelchair Dimensions Guide

## MANUAL

	Transport	Transport Aluminum	Transport Heavy-Duty	Veranda™	Tracer® EX2
HCPCS code	n/a	n/a	n/a	K0001	K0001, K0002
Widths	17", 19"	17", 19"	22"	18"	16", 18", 20"
Depths	16"	15.5", 16"	18"	16"	16"
Overall widths	19", 21"	21.5", 23.5"	28"	(Perm. arms) (Rem. arms)	25.5", 27.25" (FF) 24.75" 24.5", 26.5", 28.5"
Overall depths	27"	24.25"	36.5"		32"
Seat-to-floor	19.5"	19.5"	19.25"	19.5"	(Rem./Perm.) 17.5", 19.5"
Overall weight	24.5 lb., 25 lb.	19 lb.	41 lb.	37 lb.	36 lb.
Weight capacity	250 lb.	250 lb.	400 lb.	250 lb.	250 lb.

## LIGHTWEIGHT

	Tracer® SX5	Tracer® SX5 Recliner	9000 SL	9000 XT	9000 XT Recliner
HCPCS code	K0003, K0006¹	K0003 & E1226 K0006 & E1226	K0004	K0004	K0004 & E1226
Widths	14", 16", 18", 20", 22"	14", 16", 18", 20", 22"	16", 18", 20"	14", 15", 16", 17", 18", 19", 20", 22" 1" increments	14", 16", 18", 20", 22"
Depths	16"	16"	16", 18"²	16", 17"², 18"²	16", 17"², 18"²
Overall widths	seat width plus 8.5"	seat width plus 8.5"	seat width plus 7.5"	seat width plus 7.25"	seat width plus 7.5"
Overall depths	32"	32", 53.5" in recline	30"	30"	36", 53.5" in recline
Seat-to-floor	17.5", 19.5"	17.5", 19.5"	17.5", 19.5" 15.5"³, 16.5"³, 18.5"³	17.5", 18.5", 19.5" 15.5", 16.5"	17.5"³, 18.5"³, 19.5"
Overall weight	34 lb.	53 lb.	33 lb.	31 lb.	50 lb.
Weight capacity	250 lb., 300 lb.⁵	250 lb. 300 lb.⁵	250 lb.	250 lb.	250 lb.

## BARIATRIC HEAVY-DUTY

	Tracer® IV	9000 XDT	9000 Topaz™	900	900 Recliner
HCPCS code	K0007	K0007	K0007	K0001 & K0006	K0001 & E1226 K0006 & E1226
Widths	18", 20", 22", 24"	16"-20", 22" (1" increments)	20", 22", 24", 26", 28", 30"	14"-24" (1" increments)	14"-24" (1" increments)
Depths	18", 20"²	16"-20" (1" increments)	18", 20"	13"-22" (1" increments)	13"-22" (1" increments)
Overall widths	seat width plus 8.25"	seat width plus 7.5"	seat width plus 7.5"	seat width plus 7.5"	seat width plus 7.5"
Overall depths	33.5"	30"	35"	32"	32"
Seat-to-floor	17.5", 19.5"	17.5", 19.5", 21.5"⁴	15.5"³, 17.5", 19.5"	18" hemi, 20" adult (19", 21", 22", 23", 24")⁴	18" hemi, 20" adult (19", 21", 22", 23", 24")⁴
Overall weight	42 lb.	37 lb.	85 lb.	differs per configuration	differs per configuration
Weight capacity	350 lb. 450 lb. ³	350 lb.	700 lb. 1000 lb. HDPG	250 lb./275 lb. 300 lb./350 lb.	350 lb.

## PEDIATRIC

	9000 Jymni™	9000 Jymni™ Recliner
HCPCS code	E1236	E1236 & E1226
Widths	10", 12", 14", 16"	10", 12", 14", 16"
Depths	10", 12", 14"	10", 12", 14"
Overall widths	seat width plus 7.5"	seat width plus 7.5"
Overall depths	27.5"	27.5"
Seat-to-floor	15", 16", 17"³	15", 16", 17"³
Overall weight	31 lb.	40 lb.
Weight capacity	125 lb.	125 lb.

- (1.) 20" and 22" only.
- (2.) By seat extension.
- (3.) Available with different wheel and caster packages.
- (4.) By frame modification.
- (5.) 300 lb. weight capacity on 20" and 22" widths.

**Invacare® Transport chair** is designed for safe and efficient patient transport. The Transport chair has the added advantage of sharing interchangeable parts with the other chairs in the transport series. The Transport chair is compact and lightweight.

TRAN19FR Transport Chair.



## TRAN17FR and TRAN19FR Features

- Stylish, Silver Vein, powder-coated carbon steel frame
- Footrests are included with the chair and match frame finish
- Black nylon upholstery is flame retardant and bacteria resistant
- Full-length arms are padded for comfort
- Carry straps on seat allow for ease of folding and lifting
- Fold-down back makes transport and storage easy

## Specifications

Model numbers	TRAN17FR	TRAN19FR
<b>Chair dimensions</b>		
Seat width	17"	19"
Seat depth	16"	16"
Back height	19" fold-down	19" fold-down
Seat-to-floor height	19"	19"
<b>Casters</b>		
	8"	8"
<b>Front riggings</b>		
Swingaway footrest	17"-21" knee-to-heel	17"-21" knee-to-heel
Swingaway elevating legrest	17.5"-21" knee-to-heel	17.5"-21" knee-to-heel
<b>Arm styles</b>		
	Permanent full-length, padded	Permanent full-length, padded
<b>Overall dimensions</b>		
Overall width	19"	21"
Folded width	7.25"	7.75"
Overall depth w/o riggings	27"	27"
Overall height	39"	39"
<b>Weight w/o riggings</b>	24.5 lb.	25 lb.
<b>Weight capacity</b>	250 lb.	250 lb.
<b>Limited warranty</b>	12 months	12 months

Note: All specifications are approximate





ALR19HBFR Lightweight Aluminum Transport Chair in red.



**Invacare® Lightweight Aluminum Transport chairs** are designed for safety, ease and comfortable patient transport. The lightweight frames weigh only 19 lb. and incorporate a fold-down back, making these chairs easy to transport and store.

### Features

- Black nylon upholstery is flame retardant and bacteria resistant
- Full-length arms are padded for comfort
- Carry straps on seat allow for ease of folding and lifting
- Footrest painted to match frame finish
- Fold-down back makes transport and storage easy
- Weighs 19 lb. (w/o riggings)

Folded Lightweight Aluminum Transport chair is compact for ease of transport and storage.



LTTB19FR Lightweight Aluminum Transport chair in blue.

### Specifications

Model numbers	ALR19HBFR ALB19HBFR	LTTB17FR	LTTB19FR LTTB19FR
<b>Chair dimensions</b>			
Seat width	19"	17"	19"
Seat depth	16"	15.5"	15.5"
Back height	17.5"	17.5"	17.5"
Seat-to-floor height	19.25"	19.25"	19.25"
<b>Casters and wheels</b>			
Casters	8"	8"	8"
Wheels	12" flat free	8"	8"
<b>Front riggings</b>			
Swingaway footrest			
<b>Overall dimensions</b>			
Overall width	23.5"	21.5"	23.5"
Overall depth w/o riggings	24.25"	24.25"	24.25"
Overall height	37.5"	36.5"	36.5"
<b>Weight w/o riggings</b>	19 lb.	19 lb.	19 lb.
<b>Weight capacity</b>	250 lb.	250 lb.	250 lb.
<b>Limited warranty</b>	13 months	13 months	13 months

Note: All specifications are approximate

**Invacare® Heavy-Duty Transport chair** is designed for individuals requiring a transport chair that can support up to 400 lb. The Heavy-Duty Transport chair is available in a 22" seat width and comes complete with removable desk arms, swingaway footrests and 12" flat free rear wheels.

## Features

- Removable padded desk arms
- Carbon steel frame with dual crossbraces
- Swingaway footrest with aluminum footplates
- Flame retardant black nylon upholstery



## Specifications

Dimensions	TRHD22FR
Seat width	22"
Seat depth	18"
Back height	20"
Seat-to-floor height	19.5"
Casters and wheels	
Casters	8"
Wheels	12" flat free
Front riggings	
Swingaway footrest	
Overall dimensions	
Overall width open	28"
Overall depth w/o riggings	36.5"
Weight capacity	
	400 lb.
Limited warranty	
	13 months

**Invacare® Veranda™ Wheelchair** provides comfort and mobility in an economical package. Complete with front riggings packaged with the chair, the Invacare Veranda Wheelchair combines style and durability at an affordable price.

## Features

- Stylish powder-coated frame includes front riggings
  - Footrests match chair
  - Legrests are chrome
- Carry pocket on back
- Large step-tube end cap
- Padded nylon upholstery
- Comfortable padded arms



Pocket on back.



Large step-tube end cap.



Step-tube.

## Specifications

<b>Seat sizes</b>	
Width	18"
Depth	16"
<b>Seat-to-floor height</b>	
Removable arm	19.5"
Permanent arm	19.5"
<b>Back height</b>	
	18"
<b>Casters and wheels</b>	
Casters	8"
Wheels	24"
<b>Front riggings</b>	
Hemi swingaway footrest	16.5" - 19.5" knee-to-heel
Hemi swingaway padded elevating legrest	17.5" - 21" knee-to-heel
<b>Arm styles</b>	
Permanent full-length, fixed height arm	
Removable desk-length, fixed height arm	
<b>Weight capacity</b>	250 lb.
<b>Product weight</b>	37 lb.
<b>Limited warranty</b>	1 year



**Invacare® Tracer® EX2 wheelchair** sets the benchmark in manual wheelchairs. A true dual axle position allows for repositioning the 24" rear wheels and 8" casters for adult and hemi seat-to-floor heights. Offset permanent arms offer full seat width up to 20" with a permanent arm, hemi-spaced footrest and full range of accessories. Incorporating the design and technology of the Invacare 9000 series, the Tracer EX2 wheelchair has interchangeable components with the 9000 series chairs.



Invacare® Tracer® EX2 Wheelchair

## Features

- Durable, low-maintenance, triple chrome-plated, carbon steel frame is long-lasting
- Dual axle positions allow variation of seat-to-floor heights
- Offset permanent arms available in 16", 18" and 20" widths
- 14-gauge crossbraces add strength and durability
- Urethane rear tires mounted on "no flex" wheels offer superior performance
- Low-maintenance, dual-sealed precision bearings
- Heavy-duty inner liners keep seat and back from stretching
- Flame-retardant upholstery resists mildew and bacteria, as well as cold-crack and UV damage
- Upholstery is dual-embossed
- Meets RESNA standards for manual wheelchairs in product performance

## Specifications

Seat sizes	
Widths	16", 18", 20"
Depths	16" standard
Seat-to-floor heights	
	17.5", 19.5"
Back height	
	16" fixed
Casters and wheels	
Casters	8"
Wheels	24"
Front riggings	
Hemi swingaway footrest	17"-21" knee-to-heel
Hemi swingaway padded elevating legrest	17.5"-21" knee-to-heel
Articulating elevating legrest	17"-25" knee-to-heel
(Footplates available in aluminum or composite)	

Arm styles	
	Permanent full-length, padded
	Full-length fixed or adjustable height, padded, removable
	Desk-length fixed or adjustable height, padded, removable
	(All arms are conventional)
Weight capacity	
	250 lb.
Product weight (TREX2/WD86/28)	
	36 lb.
Limited warranty	
	5 years on frame and crossbraces



*Offset permanent arms allow for full seat width between arms.*





**Invacare® Tracer® SX5 wheelchair's** lightweight frame, weighing less than 36 pounds, makes this chair perfect for rental and long- or short-term use. This wheelchair offers multiple seat widths, arm styles, sectional back and seat-to-floor heights by utilizing the dual axle position frame base. The 20" and 22" widths include a semi-pneumatic caster to accommodate a weight capacity of 300 lb. Combining the design and technology of the Invacare 9000 series wheelchairs makes it possible to interchange components with the Tracer SX5 wheelchair.

Invacare® Tracer® SX5 Chair

**Features**

- Durable, low-maintenance, triple chrome-plated, carbon steel frame is long-lasting
- Dual axle positions allow variation of seat-to-floor heights
- 14-gauge crossbraces add strength and durability
- Urethane rear tires mounted on “no flex” wheels offer superior performance
- Sectional back available in 16" and 18" back heights
- Low-maintenance, dual-sealed precision bearings
- Heavy-duty inner liners keep seat and back from stretching
- Flame-retardant upholstery resists mildew and bacteria, as well as cold-crack and UV damage
- Meets RESNA standards for manual wheelchairs in product performance

**Specifications**

Seat sizes	
Widths	14", 16", 18", 20", 22"
Depths	16"
Seat-to-floor heights	
	17.5", 19.5"
Back heights	
	16", 18" sectional
Casters and wheels	
Casters	6", 8"
Wheels	20", 22", 24"
Front Riggings	
Hemi swingaway footrest	17"-21" knee-to-heel
Hemi swingaway padded elevating legrest	17.5"-21" knee-to-heel
Articulating elevating legrest	17"-25" knee-to-heel

(Footplates available in aluminum or composite)

Arm styles	
	Full-length fixed height, padded
	Desk-length fixed height, padded
	Full-length adjustable height, padded
	Desk-length adjustable height, padded
(All arms are flip back non-removable)	
Weight capacity	
	250 lb. (300 lb. on 20" and 22" width)
Product weight ( TRSX5/WD86/28FB)	
	34 lb.
Limited warranty	
	5 years on frame and crossbraces

**Invacare® Tracer® SX5 Recliner wheelchair** offers the durability of a lightweight manual wheelchair frame with the added versatility and comfort of a full reclining back. The Tracer SX5 Recliner wheelchair offers dynamic recline range from 90° to 180°. This chair is available with multiple seat widths, arm styles, front riggings, a full range of accessories and a 300 lb. weight capacity on 20" and 22" widths.

## Features

- Dynamic range of recline from 90° to 180°
- Durable, low-maintenance, triple chrome-plated, carbon steel frame
- Urethane rear tires, mounted on "no flex" wheels, offer superior performance
- Low-maintenance, dual-sealed precision bearings
- Heavy-duty inner liners keep seat and back from stretching
- Flame-retardant upholstery resists mildew and bacteria, as well as cold-crack and UV damage
- Upholstery is dual-embossed
- Meets RESNA standards for manual wheelchairs in product performance



## Specifications

Seat sizes		Arm styles	
Widths	14", 16", 18", 20", 22"	Full-length fixed height, padded, removable	
Depths	16"	Desk-length fixed height, padded, removable	
<b>Seat-to-floor heights</b>	17.5", 19.5"	Full-length adjustable height, padded, removable	
<b>Back height</b>	34" recliner (24" high back, 10" removable headrest)	Desk-length adjustable height, padded, removable	
<b>Casters and wheels</b>		(All arms are conventional and removable)	
Casters	8"	<b>Weight capacity</b>	250 lb. (300 lb. on 20" and 22" width)
Wheels	20", 22", 24"	<b>Product weight</b> (TRSX5/WD86/RC/28)	53 lb.
<b>Front riggings</b>		<b>Limited warranty</b>	5 years on frame and crossbraces
Hemi swingaway footrest	17"-20" knee-to-heel		
Hemi swingaway padded elevating legrest	17.5"-21" knee-to-heel		
Articulating elevating legrest	17"-25" knee-to-heel		
(Footplates available in aluminum or composite)			





**Invacare® 9000 SL wheelchair** is the perfect high-strength lightweight rental product for those who want quality and durability at a moderate price. This low-maintenance wheelchair also has a full complement of options and accessories. Its contemporary design and high-performance frame make the 9000 SL wheelchair a superior value.

**Features**

- Stylish, contemporary carbon steel frame is long-lasting
- Multiple frame color variations for customizing
- Dual axle positions allow variations of seat-to-floor heights
- Urethane rear tires mounted on “no flex” wheels offer superior performance
- Urethane casters for better ride and lighter weight
- Low-maintenance, dual-sealed precision bearings
- Heavy-duty inner liners keep seat and back from stretching
- Flame-retardant upholstery resists mildew and bacteria, as well as cold-crack and UV damage
- Space-saver arms reduce overall frame width without limiting seat width
- Meets RESNA standards for manual wheelchairs in product performance

Invacare® 9000 SL Wheelchair

**Specifications**

Seat sizes	
Widths	16", 18", 20"
Depths (optional)	16" standard, 18" by seat extension
Seat-to-floor heights	
	17.5", 19.5" 15.5", 16.5", 18.5" with different wheel and caster packages
Back heights - adjustable	
	15"-17" or 17"-19"
Casters and Wheels	
Casters	6", 8"
Wheels	20", 22", 24"
Front riggings	
Hemi swingaway footrest	17"-21" knee-to-heel
Hemi swingaway padded elevating legrest	17.5"-21" knee-to-heel
Articulating elevating legrest	17"-25" knee-to-heel

Arm styles	
	Full-length fixed height, padded
	Desk-length fixed height, padded
	Full-length adjustable height, padded
	Desk-length adjustable height, padded
(All arm styles are space saver, flip back and non-removable)	
Weight capacity	
	250 lb.
Product weight (9SL/WD86/88)	
	33 lb.
Limited warranty	
	5 years on frame and crossbraces

(Footplates available in aluminum or composite)  
(Extra large footplates are also available)

**Invacare® 9000 XT wheelchair** is a high performance, low maintenance and low total lifetime cost product. The 9000 XT wheelchair is simply the most versatile lightweight wheelchair available from Invacare, boasting an extensive offering of frame styles, seat-to-floor heights, back styles, widths, depths, frame colors and a wide range of options and accessories. The 9000 XT wheelchair components are interchangeable with all other 9000 series and Tracer® series chairs.



The super-hemi (single-axle) seat-to-floor height is achieved with 22" rear wheels and 6" casters. A 13.5" seat-to-floor height is achieved with 20" rear wheels and 6" casters.

9000 XT wheelchair with offset axle and adjustable angle caster will allow additional seat-to-floor heights and increase seating and positioning capabilities. Offset axle offers center-of-gravity adjustment which increases maneuverability and stability.

## Features

- Stylish, contemporary carbon steel frame with aluminum crossbraces
- Multiple frame color variations for customizing
- Dual axle positions allow variation of seat-to-floor heights
- Offset axle position allows adjustment of center-of-gravity to increase maneuverability or stability to meet each user's skill level
- Urethane rear tires mounted on "no flex" wheels offer superior performance
- Urethane casters for better ride and lighter weight
- Adjustable caster journal can be used with or without offset axle option (Refer to service manual for a complete list of seat-to-floor heights and angles that are reconfigurable only by the provider)
- Flame-retardant upholstery resists mildew and bacteria, as well as cold-crack and UV damage
- Meets RESNA standards for manual wheelchairs in product performance

## Specifications

Seat sizes	
Widths	14", 15", 16", 17", 18", 19", 20", 22" adult to hemi frame 14", 15", 16", 17", 18" super-hemi frame
Depths	16" standard frame 17", 18" by seat extensions, adult to hemi frame 16", 17" super-hemi frame (different frame)
Seat-to-floor heights*	17.5", 18.5", 19.5" 15.5", 16.5" with different wheel and caster packages 13.5", 14.5" super-hemi
Back heights	15" - 19" adjustable height Adjustable angle available as option (-5° to 20° adjustment)**
Casters and wheels	
Casters	6", 8"
Wheels	20", 22", 24"

Front riggings	
Hemi swingaway footrest	17" - 21" knee-to-heel
Hemi swingaway padded elevating legrest	17.5" - 21" knee-to-heel
Super-hemi swingaway footrest	11" - 17" knee-to-heel
Super-hemi swingaway padded elevating legrest	11" - 17" knee-to-heel
Articulating elevating legrest	17" - 25" knee-to-heel
(Footplates available in aluminum or composite)	
Arm styles	
Full-length fixed height, padded, flip back, removable	
Desk-length fixed height, padded, flip back, removable	
Full-length adjustable height, padded, flip back, removable	
Desk-length adjustable height, padded, flip back, removable	
(All arm styles available conventional or space saver)	
Weight capacity	250 lb.
Product weight (9XT/WD86/88)	31 lb.
Limited warranty	5 years on frame and crossbraces

\*See service manual for additional seat-to-floor heights and seat angles available.  
\*\*Seat angle adjustment of 0° and 6° that are reconfigurable only by the provider, can be found in the service manual.



**Invacare® 9000 XT Recliner wheelchair** is the number one choice for individuals who demand a truly versatile, yet moderately priced, lightweight wheelchair. The 9000 XT Recliner wheelchair can be configured into an endless number of seat widths, depths and heights, and has multiple frame and upholstery options. Components and accessories are interchangeable with the other 9000 series chairs.

## Features

- Stylish, contemporary carbon steel frame is long-lasting
- Dynamic recline range from 95° to 175°, +/- 5°
- Rear axle base moves, providing stable center-of-gravity in recline position
- Multiple frame color variations for customizing
- Multiple wheel offerings allow variation of seat-to-floor heights
- Urethane rear tires mounted on “no flex” wheels offer superior performance
- Urethane casters for better ride and lighter weight
- Low-maintenance, dual-sealed precision bearings
- Heavy-duty inner liners keep seat and back from stretching
- Flame-retardant upholstery resists mildew and bacteria, as well as cold-crack and UV damage
- Stocked with attendant (standard) or patient-operated wheel locks
- Meets RESNA standards for manual wheelchairs in product performance

Invacare® 9000 XT Recliner Wheelchair



## Specifications

Seat sizes	
Widths	14", 16", 18", 20", 22"
Depths	16", 17", 18"
Seat-to-floor heights	
	19.5" 17.5", 18.5" with rear wheel package
Back height	
	34" recliner (24" high back, 10" removable headrest)
Casters and wheels	
Casters	8"
Wheels	20", 22", 24"
Front riggings	
Hemi swingaway footrest	17"- 20" knee-to-heel
Hemi swingaway padded elevating legrest	17.5"- 21" knee-to-heel
Hemi articulating elevating legrest	17"- 25" knee-to-heel
(Footplates available in aluminum or composite)	

Arm styles	
	Full-length fixed height, padded
	Desk-length fixed height, padded
	Full-length adjustable height, padded
	Desk-length adjustable height, padded
	(All arms are conventional and removable)
Weight capacity	
	250 lb.
Product weight (9RC/WD86/R/28/2R)	
	50 lb.
Limited warranty	
	5 years on frame and crossbraces

**Invacare® Tracer® IV wheelchair** features superior durability, rollability and streamlined looks. It is designed for the active individual who needs the strength of a reinforced heavy-duty frame. Its many options include components interchangeable within the Tracer series. The Tracer IV wheelchair is long-lasting and low-maintenance.

## Features

- Dual axle position allows variation of seat-to-floor heights
- Durable, low-maintenance, triple chrome-plated, carbon steel frame is long-lasting
- Reinforced frame includes gusseted sides, caster journals and dual crossbraces
- Corded urethane rear tires (350 lb.) and pneumatic flat free tires (450 lb.) mounted on “no flex” wheels offer superior performance
- Low-maintenance, dual-sealed precision bearings
- Heavy-duty inner liners keep seat and back from stretching
- Flame-retardant upholstery resists mildew and bacteria, as well as cold-crack and UV damage
- Upholstery is dual-embossed



Invacare® Tracer® IV Wheelchair



*Heavy-duty package increases weight capacity to 450 lb. and consists of heavy-duty composite wheels with pneumatic tires with flat-free inserts and semi-pneumatic casters.*

## Specifications

Seat sizes		Arm styles	
Widths	18", 20", 22", 24"	Full-length fixed height, padded, removable	
Depths	18" (standard), 20" (by seat extension)	Desk-length fixed height, padded, removable	
<b>Seat-to-floor heights</b>	17.5", 19.5"	Full-length adjustable height, padded, removable	
<b>Back height</b>	16" fixed	Desk-length adjustable height, padded, removable (All arms are conventional)	
<b>Casters and wheels</b>		<b>Weight capacity</b>	350 lb., 450 lb.*
Casters	8"	<b>Product weight</b> (T4/WD28/28)	42 lb.
Wheels	24"	<b>Limited warranty</b>	5 years on frame and crossbraces
<b>Front riggings</b>		* Heavy-duty package only.	
Swingaway footrest	17" - 21" knee-to-heel		
Swingaway padded elevating legrest	17.5" - 21" knee-to-heel		
Articulating elevating legrest	17" - 25" knee-to-heel		
(Footplates available in aluminum and composite)			





**Invacare® 9000 XDT wheelchair** is designed for individuals who demand an extra wide, heavy-duty or tall chair with seat-to-floor heights ranging from hemi through tall. The high-performance 9000 XDT wheelchair provides a 350 lb. weight capacity and the components are interchangeable with the other 9000 series wheelchairs.

**Features**

- Durable, low-maintenance, carbon steel frame is long-lasting
- Tall frames are designed to accommodate taller individuals and provide a more comfortable ride
- Multiple frame color variations for customizing
- Triple-axle positions allow wide variation of seat-to-floor heights
- Urethane rear tires mounted on “no flex” wheels offer superior performance
- Urethane casters for better ride and lighter weight
- Low-maintenance, dual-sealed precision bearings
- Heavy-duty inner liners keep seat and back from stretching
- Flame-retardant upholstery resists mildew and bacteria, as well as cold-crack and UV damage



**Specifications**

Seat sizes	
Widths	16", 17", 18", 19", 20", 22" tall to adult to hemi frame
Depths	16", 17", 18", 19", 20"
Seat-to-floor heights	
	17.5", 19.5", 21.5"
Back heights - adjustable	
	15"-19" or 14"-18"
Casters and wheels	
Casters	8"
Wheels	24"
Front riggings	
Hemi swingaway footrest	17"-21" knee-to-heel
Hemi swingaway padded elevating legrest	17.5"-21" knee-to-heel
Super-hemi swingaway footrest	11"-17" knee-to-heel
Super-hemi swingaway padded elevating legrest	11"-17" knee-to-heel
Articulating elevating legrest	17"-25" knee-to-heel

(Footplates available in aluminum or composite)

Arm styles	
	Full-length fixed height, padded, flip back, removable
	Desk-length fixed height, padded, flip back, removable
	Full-length adjustable height, padded, flip back, removable
	Desk-length adjustable height, padded, flip back, removable
	(All arm styles available conventional or space saver)
Weight capacity	
	350 lb.
Product weight (9XDT/WD08/28)	
	37 lb.
Limited warranty	
	5 years on frame and crossbraces

Invacare® 9000 XDT Wheelchair

**Invacare® 9000 Topaz™ wheelchair** is designed specifically to suit the unique needs of bariatric patients. The Topaz wheelchair combines the strength and durability of a carbon steel frame with the comfort of heavy-duty front riggings and arms for proper positioning. With a variety of seat widths and depths, frame reinforcements that include gusseted sides, caster journals and dual heavy-duty crossbraces, this chair provides not only ease in maneuverability but proven stability.



## Features

- Available in vinyl or nylon upholstery
- Durable low-maintenance, carbon steel frame is long-lasting
- Reinforced frame includes gusseted sides, caster journals and dual heavy-duty crossbraces
- Multiple frame color variations available for customizing
- Heavy-duty front riggings provide proper positioning for feet with footrest and elevating legrest
- Heavy-duty arms designed to accommodate weight capacity and provide proper positioning
- Dual axle positions allow for quick and simple seat-to-floor height variations, 17.5" and 19.5"
- HDPG option for 1,000 lb. weight capacity
- Heavy-duty triple inner liners keep seat and back from stretching
- Flame-retardant upholstery resists mildew and bacteria, as well as cold-crack and UV damage

## Specifications

Seat sizes	
Widths	20", 22", 24", 26", 28", 30"
Depths	18", 20"
Seat-to-floor heights	
	17.5", 19.5" 15.5" with different wheel and caster packages
Back heights - adjustable	
	16"-18"
Casters and wheels	
Casters	6", 8"
Wheels	20", 24"
Front riggings	
	Swingaway footrest
	Swingaway padded elevating legrest

Arm styles	
	Full-length fixed height, padded
	Desk-length fixed height, padded
	Full-length adjustable height, padded
	Desk-length adjustable height, padded
	(All arm styles available conventional and removable)
Weight capacity	
	700 lb.
HDPG option	1, 000 lb.
Product weight (9TPZ/WD2818/28)	
	85 lb.
Limited warranty	
	3 years on frame and crossbraces





Invacare® 900 wheelchair is no longer available in chrome.

**Invacare® 900 Series wheelchair** is designed to meet the physical needs of the most demanding consumer. This reinforced 900 wheelchair is strengthened in a number of ways, including additional supports, gussets and reinforcements, making it extremely durable and reliable. The 900 redefines the term “custom wheelchair.” Each one is built to the exact specification of the consumer. The chair is available in multiple widths and depths, back styles, seat-to-floor heights and weight limits up to 350 lb., resulting in a chair that can accommodate almost any user.



## Features

- Durable carbon steel frame finished in silver vein
- Multiple width and depth combinations can accommodate almost any consumer
- Gusseted frame option withstands heavy use
- Dual crossbrace option provides extra strength and rigidity
- Shock absorbing forks help the front-end handle rough terrain

## Specifications

Seat sizes		Arm styles
Widths	14", 15", 16", 17", 18", 19", 20", 21", 22", 23", 24"	Full-length fixed height, padded, removable Desk-length fixed height, padded, removable
Depths	13", 14", 15", 16", 17", 18", 19", 20", 21", 22"	Full-length adjustable height, padded, removable Desk-length adjustable height, padded, removable (All arms are conventional or space-saver)
<b>Seat-to-floor heights</b>	18" hemi, 20" adult 19", 21", 22", 23", 24" by frame modification	<b>Weight capacity</b> 250 lb., 275 lb., (Dependent on custom configuration) 300 lb., 350 lb.
<b>Back heights</b>	14"-24" sectional back 14"-24" permanent fixed back height (1" increments)	<b>Product weight</b> Dependent on custom configurations
<b>Casters and wheels</b>		<b>Limited warranty</b> 5 years on frame and crossbraces
Casters	8"	
Wheels	24"	

**Invacare® 900 Recliner wheelchair** is custom-made with multiple widths and depths. The 900 recliner, like the 900 wheelchair, leads the way in durability and reliability. Frame gussets and reinforcements allow this chair to meet the special needs of those individuals who need a reclining back wheelchair that accommodates a weight capacity of 350 lb.



Invacare® 900 Recliner wheelchair is no longer available in chrome.

## Features

- Finished in silver vein
- Multiple width and depth combinations can accommodate almost any user
- Gussetted frame option withstands heavy use
- Dual crossbrace option provides extra strength and rigidity
- Shock absorbing forks help the front-end handle rough terrain

## Specifications

Seat sizes		Arm styles	
Widths	14", 15", 16", 17", 18", 19", 20", 21", 22", 23", 24"	Full-length fixed height, padded, removable	
Depths	13", 14", 15", 16", 17", 18", 19", 20", 21", 22"	Desk-length fixed height, padded, removable	
<b>Seat-to-floor heights</b>	18" hemi, 20" adult 19", 21", 22", 23", 24" by frame modification	Full-length adjustable height, padded, removable	
<b>Back heights</b>	32" reclining 22" high back and 10" removable headrest	Desk-length adjustable height, padded, removable (All arms are conventional)	
<b>Casters and wheels</b>		<b>Weight capacity</b>	350 lb.
Casters	8"	<b>Product weight</b>	Dependent on custom configuration
Wheels	24"	<b>Limited warranty</b>	5 years on frame and crossbraces





**Invacare® 9000 Jymni™ wheelchair** offers your growing list of pediatric clients versatility, functionality and maneuverability. This chair is specifically designed to suit the needs of your smaller clients and offers features like a durable carbon-steel frame and easy adjustability.

## Features

- Durable, carbon steel frame is long-lasting
- Stroller handles provide ergonomic positioning for caregiver and remove for ease in transporting
- Adjustable front riggings provide ideal positioning for pediatric clients
- Urethane rear tires mounted on “no flex” wheels offer superior performance
- Virtually no-maintenance, dual-sealed precision bearings
- Flame-retardant upholstery resists mildew and bacteria, as well as cold-crack and UV damage
- Dual-axle positions allow for quick and simple seat-to-floor height adjustments of 15" and 16"
- Seat width and depth options provide proper positioning
- Adjustable angle back easily changes from -5° to 20° in 5° increments
- Meets RESNA standards for manual wheelchairs in product performance

## Specifications

Seat sizes	
Widths	10", 12", 14", 16"
Depths	10", 12", 14"
<b>Seat-to-floor heights</b>	15", 16" 17" with different wheel and caster packages
<b>Back heights - adjustable</b>	14" - 15"
Casters and wheels	
Casters	6"
Wheels	20", 22"
Front riggings	
70° swingaway footrest	7" - 11" knee-to-heel
80° swingaway footrest	11"-15" knee-to-heel
90° swingaway footrest	5" - 10" knee-to-heel
Elevating legrest	7" - 14" or 11" - 15" knee-to-heel

Arm styles	
Full-length fixed height, padded, flip back, removable	
Desk-length fixed height, padded, flip back, removable	
Full-length adjustable height, padded, flip back, removable	
Desk-length adjustable height, padded, flip back, removable	
(All arm styles available conventional or space saver)	
<b>Weight capacity</b>	125 lb.
<b>Product weight (SJYL/WD22/88JY)</b>	31 lb.
<b>Limited warranty</b>	5 years on frame and crossbraces

**Invacare® 9000 Jymni™ Recliner wheelchair** offers your growing list of pediatric clients versatility, functionality and maneuverability, with the added comfort of a reclining back. This chair is specifically designed to suit the needs of your smaller clients and provides features like a variety of width and depth options, a recline range of 95° to 160° and multiple frame color options.

## Features

- Durable, carbon steel frame is long-lasting
- Dynamic recline from 95° to 160°
- Stroller handles provide ergonomic positioning for caregiver and remove for ease in transporting
- Adjustable front riggings provide ideal positioning for pediatric clients
- Flame-retardant upholstery resists mildew and bacteria, as well as cold-crack and UV damage
- Seat width and depth options provide proper positioning
- Meets RESNA standards for manual wheelchairs in product performance



9000 Jymni Recliner allows for a dynamic recline range of 95° to 160°. Multiple frame color variations for customizing.

## Specifications

Seat sizes	
Widths	10", 12", 14", 16"
Depths	10", 12", 14"
Seat-to-floor heights	
	15", 16" 17" with different wheel and caster packages
Back heights	
	27" reclining 16" high back and 11" removable headrest
Casters and wheels	
Casters	8"
Wheels	24"
Front riggings	
70° swingaway footrest	7" - 11" knee-to-heel
80° swingaway footrest	11" - 15" knee-to-heel
90° swingaway footrest	5" - 10" knee-to-heel
Elevating legrest	7" - 14" or 11" - 15" knee-to-heel

Arm styles	
	Full-length fixed height, padded, flip back, removable
	Desk-length fixed height, padded, flip back, removable
	Full-length adjustable height, padded, flip back, removable
	Desk-length adjustable height, padded, flip back, removable (All arm styles available conventional)
<b>Weight capacity</b>	125 lb.
<b>Product weight</b> (9JYLT/WD42/28JY/R)	40 lb.
<b>Limited warranty</b>	5 years on frame and crossbraces





**Invacare® CLD** (Cyclical Lever Drive) was designed for individuals to self-propel themselves with one arm, giving the opportunity to be more active, mobile and independent. With its front-caster steering mechanism, simple rowing motion design and adjustability in height and stroke length, the Invacare CLD is the answer to an easy-to-operate one-arm drive.

There are no service requirements for the CLD mechanism, although service requirements for the wheelchair apply. Kits available for provider installation. Right- or left-handed configuration. Provider installed kits for Tracer® EX2, Tracer® SX5 and 9000 SL. See 9000 XT price list (95-66) for availability.



Wheel lock position.

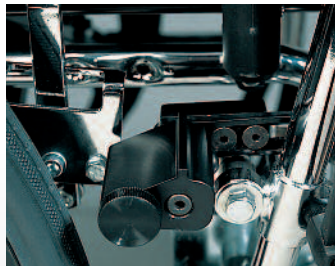

Wheel braking position.

### Specifications

Mechanism weight	9.1 lb.
Added width to chair	1.5"
Stroke length	15"-16"
Grip height adjustment	15"-18"
Mechanism color	Black/chrome
Installation	Right- or left-hand
Weight limit	250 lb.
Limited warranty	2 years



Easy to disengage.



**Folding ramps** offer an economical alternative to the motorized lift, designed for ease of use and durability. They are ideal for both manual and power wheelchairs, as well as 3- or 4-wheel scooters. Plus, they are extremely lightweight for effortless transport.

### Features

- Sturdy and dependable 600 lb. weight capacity
- Ideal for manual or power wheelchairs and 3- or 4-wheel scooters
- Convenient carrying handle is standard on all ramps
- Heavy-duty industrial Velcro® strap ensures ramp security during transportation
- Transports and stores like a suitcase
- High-traction tape on the surface is long-lasting and maintenance-free
- Stocked in Invacare's warehouse

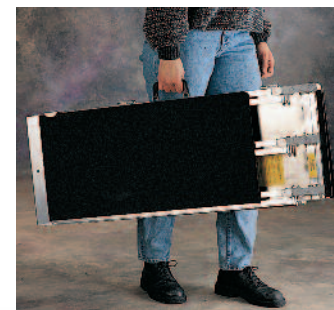

Unique folding design makes ramps easy to carry.

### Specifications

	Model no. ICR630	Model no. ICR330
Size	6' l x 30" w	3' l x 30" w
Style	Multifold	Single fold
Folded size	40.625" l x 16" w x 8.5" d	36" l x 16" w x 4" d
Product weight	28 lb.	14 lb.
Weight capacity	600 lb.	600 lb.
Limited warranty	1 year	1 year

Ramps are manufactured by Prairie View Industries and distributed by Invacare Corporation.



Front Rigging Non-removable Device  
1820



Non-folding Device  
1335 (14"-22" w)  
1335XL (24"-30" w)



Axles  
1. 1577QR – Quick Release  
2. 9357SH – Super Low Amputee Attachment  
3. 9357L – Amputee Attachment  
4. OFFAXL – Off Axle



Overhead Anti-Theft Device  
1514



Accessories  
1. 1300 – Utility Tray  
2. 1209 – Tire Pump  
3. 1305L – Crutch & Cane Carrier  
4. 1100 – Tool Kit  
5. 1571 – Fabric Clothing Protectors



Seat/Chest Positioning Straps  
1. 1321BK/7321BK – Hook and Loop  
2. 1515 – Auto Style Buckle  
3. 1311BK/7311BK – Airline Buckle



Anti-Tippers  
1. 9758 – Rear Anti-Tippers  
2. 1360SH – Super Low Adjustable  
3. 1360A – Adjustable Rear Anti-Tippers  
4. 1360 – Adjustable Rear Anti-Tippers  
5. 2226 – Front Anti-Tippers



IV/O<sub>2</sub> Holders  
1. 1497 – O<sub>2</sub> Holder Package Assembly  
2. 1496 – IV/O<sub>2</sub> Holder Package Assembly  
3. 2218 – IV Rod, Telescopic  
4. 2219 – IV Rod, Telescopic  
1322SXR – IV Rod and Bracket



Upholstery  
1. ImpactG – Impact Guards  
2. STC – Stencil Back Upholstery  
3. 1160 – Seat Pouch  
4. BP-02 – Backpack – (shown in Large 16" and Small 14"-16")

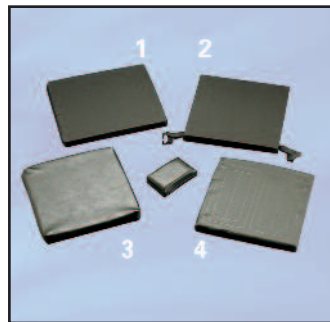

Upholstery  
1. 9130 – Solid Back Insert  
2. 9662L – Solid Seat Insert  
3. 9120 – Solid Seat Insert  
4. 1608 – Solid Back Insert

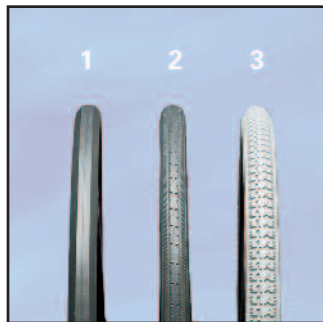

Tires  
1. Urethane  
2. Urethane - High Profile  
3. Pneumatic - Flat-Free  
All tires available in 20", 22" and 24" sizes. Available on all chairs.



Handrims  
1. CHDRM – Chrome-Plated  
2. COM – Composite  
3. AHDRM – Aluminum  
4. 1512 – Plastic Coated  
5. 1225-8 – 8 Aluminum Vertical Projection Handrim Plastic Coated  
6. 1225-12 – 12 Aluminum Vertical Projection Handrim Plastic Coated  
7. 1224-8 – 8 Aluminum Oblique Projection Handrim Plastic Coated





9000 Topaz Arms

1. T18 – Full-Length Fixed Height
2. T19 – Full-Length Adjustable Height
3. T28 – Desk-Length Fixed Height
4. T29 – Desk-Length Adjustable Height

Available on 9000 Topaz.



Lightweight Space Saver Arms

1. 79 – Full-Length Adjustable Height
2. 78 – Full-Length Fixed Height
3. 89 – Desk-Length Adjustable Height
4. 88 – Desk-Length Fixed Height



Conventional Arms

1. 18 – Full-Length Fixed Height
2. 28 – Desk-Length Fixed Height
3. 19 – Full-Length Adjustable Height
4. 29 – Desk-Length Adjustable Height

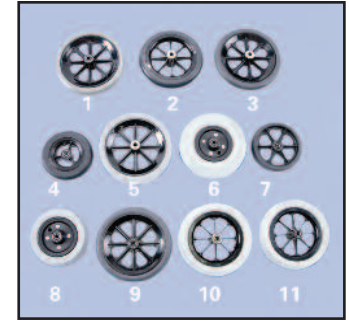

Casters

1. 1292 – 8" x 1.25" Pneumatic
2. AT903 – 8" x 1.25" Composite Urethane
3. 1255 – 8" x 1" Solid Rubber
4. AT902 – 6" Composite Urethane, 3 Spoke
5. 1252 – 8" x 1.25" Pneumatic
6. 1228 – 8" x 2" Semi-Pneumatic
7. 1687 – 6" x 1" Dark grey comp. Urethane
8. 1259 – 6" x 2" Semi-Pneumatic
9. 1290 – 8" x 1" Solid Rubber, Charcoal
10. 4252 – 8" x 1.25" Pneumatic with flat-fee inserts
11. 1492 – 8" x 1.25" Pneumatic with flat-fee inserts



Wheel Locks

1. 9697R – Pull to Lock Hill Holder
  2. 9695 – Hill Holder
  3. A1567 – Pull to Lock Clamp-on
  4. 1721 – High Push to Lock Clamp
  5. 1329BK – Toggle Wheel Lock Extension
- 9690 – Pull to Lock – 9000 XDT (not shown)  
9691 – Push to Lock (Hemi) (not shown)



9000 Topaz Front Rigging

1. TZ33A – Swingaway Footrest
2. TZ34A – Swingaway Elevating Legrest



Footrests

1. T963A/C – 60° Elevating Footrest Aluminum/Composite
2. T93HA/C/S – Aluminum/ Composite

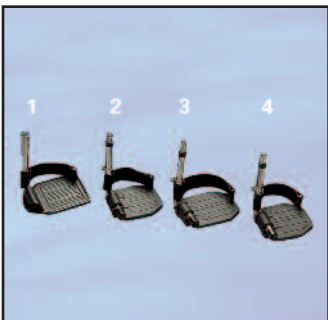

Footrests

1. SH93F – Superlow Extension Swingaway, Aluminum
2. H93M – Hemi Minimum Swingaway, Aluminum
3. H93E – Hemi Extension Swingaway, Aluminum
4. SH93ES – Super Low Extension Swingaway, Aluminum



Legrests

1. AHS4A – Hemi Smartleg® Articulating Legrest, Aluminum
2. T94HA/C – Hemi Elevating Legrest Aluminum/Composite
3. SH904MS – Superlow Elevating Legrest, Aluminum
4. AHL4A/C – Hemi Articulating Legrest, Aluminum/Composite

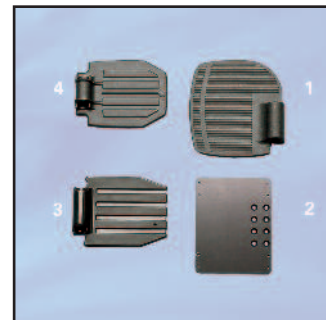

Footplates

1. 1350 – Extra Large Aluminum
2. AT5543 – Adjustable Angle
3. C – Composite
4. A – Aluminum



Straps

1. 1346 – Heel Loops
2. 1345 – Toe Loops
3. 1600 BK – Heel Loops with Ankle Straps
4. 9342 – H Strap
5. 1337 – Calf Strap
6. 1348 – Legrest Panel



**Yes, you can.®**

For upholstery and frame color availability, please refer to the corresponding wheelchair price list.

## Upholstery



U60 -  
Marina blue vinyl



U86 -  
Ruby vinyl

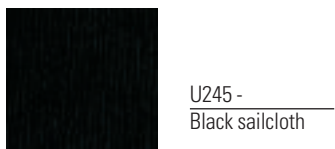

U245 -  
Black sailcloth



U67 -  
Black vinyl



U88 -  
Camel vinyl



U75 -  
Dove gray vinyl



U550 -  
Midnight blue vinyl



U85 -  
Dark blue vinyl

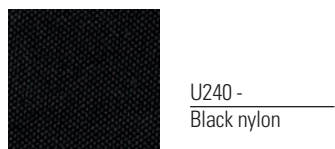

U240 -  
Black nylon

## Frame



08P -  
Deep purple

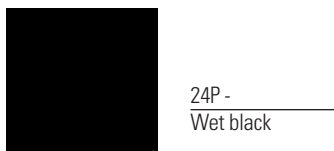

24P -  
Wet black

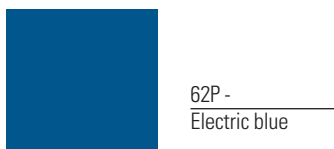

62P -  
Electric blue



84P -  
Lavender

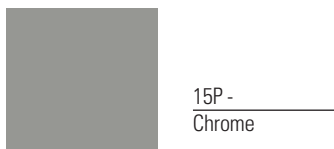

15P -  
Chrome



30P -  
Sunny yellow

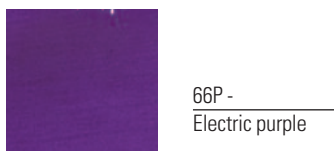

66P -  
Electric purple

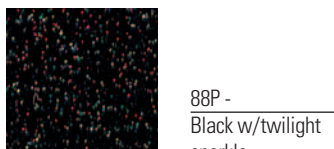

88P -  
Black w/twilight sparkle



17P -  
Cobalt blue



33P -  
Red

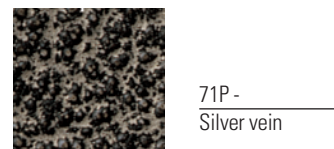

71P -  
Silver vein



104P -  
Electric teal



22P -  
Anthracite



61P -  
Electric red



83P -  
Royal blue w/grape



105P -  
Midnight blue

**Invacare Corporation**  
www.invacare.com

**USA**  
One Invacare Way  
Elyria, Ohio  
44035-4190  
(800) 333-6900

**Canada**  
570 Matheson Blvd. E.  
Unit 8  
Mississauga, Ontario  
L4Z 4G4 Canada  
(800) 668-5324

© 2009 Invacare Corporation All rights reserved. Trademarks are identified by the symbols ™ and ©. All trademarks are owned by or licensed to Invacare Corporation unless otherwise noted. Velcro is a registered trademark of Velcro Industries B.V.

Form No. 00-261  
Rev. 08-09